

SK 30 DTA

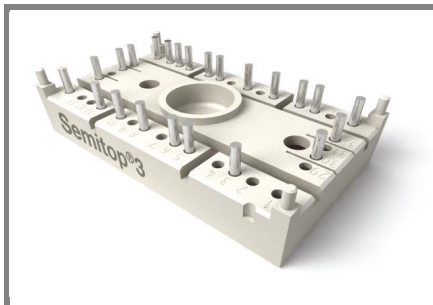

SEMITOR® 3

3-phase bridge rectifier+ series thyristor

SK 30 DTA

Target Data

Features

- Compact design
- One screw mounting
- Heat transfer and isolation through direct copper bonded aluminium oxide ceramic (DBC)
- Glass passivated thyristor chips
- Reverse voltage up to 1600 V
- High surge currents

Typical Applications

- Soft starters
- Light control
- Temperature control

V_{RSM} V	V_{RRM}, V_{DRM} V	$I_D = 25$ A ($T_s = 80$ °C)
900	800	SK 30 DTA 08
1300	1200	SK 30 DTA 12
1700	1600	SK 30 DTA 16

Characteristics $T_s = 25$ °C unless otherwise specified

Symbol	Conditions	Values	Units
I_D	$T_s = 80$ °C; Ind. load	25	A
I_{TAV}	sin. 180°; $T_s = 25$ (80) °C per thyristor	31 (19)	A
I_{FAV}	sin. 180°; $T_s = 25$ (80) °C per diode	37 (25)	A
I_{TSM}/I_{FSM}	$T_{vj} = 25$ (125) °C; 10 ms	1000 (900)	A
I^2t	$T_{vj} = 25$ (125) °C; 8,3 ... 10 ms	5000 (4000)	A ² s
T_{stg}		-40,...+125	°C
T_{solder}	terminals, 10 s	260	°C

Thyristor			
$(dv/dt)_{cr}$	$T_{vj} = 125$ °C	1000	V/μs
$(di/dt)_{cr}$	$T_{vj} = 125$ °C; $f = 50 \dots 60$ Hz	50	A/μs
t_q	$T_{vj} = 125$ °C; typ.	80	μs
I_H	$T_{vj} = 25$ °C; typ. / max.	100 / 200	mA
I_L	$T_{vj} = 25$ °C; $R_G = 33$ Ω; typ. / max.	200 / 400	mA
V_T	$T_{vj} = 25$ °C; ($I_T = 120$ A); max.	1,8	V
$V_{T(TO)}$	$T_{vj} = 125$ °C	max. 1	V
r_T	$T_{vj} = 125$ °C	max. 6	mΩ
$I_{DD}; I_{RD}$	$T_{vj} = 125$ °C; $V_{DD} = V_{DRM}; V_{RD} = V_{RRM}$	max. 8	mA
$R_{th(j-s)}$	Cont. per thyristor	0,8	K/W
T_{vj}		-40 ... +125	°C
V_{GT}	$T_{vj} = 25$ °C; d.c.	2	V
I_{GT}	$T_{vj} = 25$ °C; d.c.	100	mA
V_{GD}	$T_{vj} = 125$ °C; d.c.	0,25	V
I_{GD}	$T_{vj} = 125$ °C; d.c.	5	mA

Diode			
V_F	$T_{vj} = 25$ °C; ($I_F = 25$ A); max.	1,25	V
$V_{T(TO)}$	$T_{vj} = 150$ °C	0,8	V
r_T	$T_{vj} = 150$ °C	4	mΩ
I_{RD}	$T_{vj} = 150$ °C; $V_{RD} = V_{RRM}$	4	mA
$R_{th(j-s)}$	per diode	1,7	K/W
T_{vj}		-40...+150	°C

Mechanical data			
V_{isol}	a. c. 50 Hz; r.m.s.; 1 s / 1 min	3000 (2500)	V
M_1	mounting torque	2,5	Nm
w		30	g
Case	SEMITOR® 3	T 45	

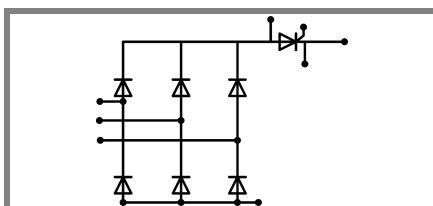

DTA

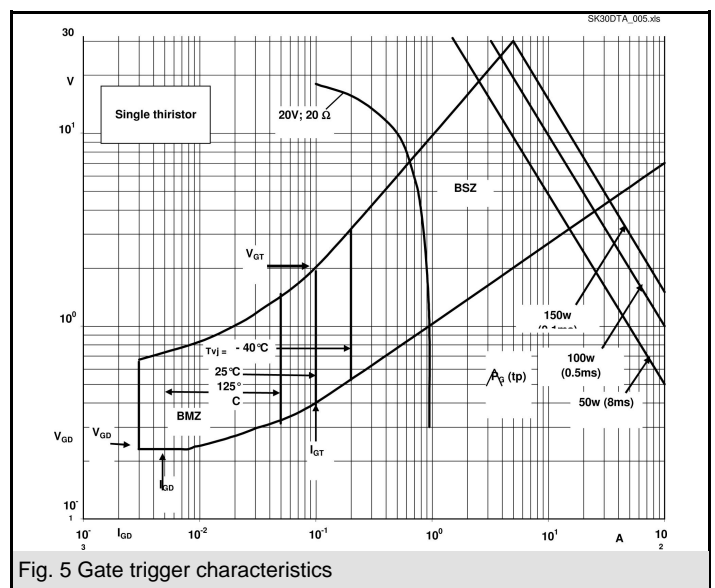
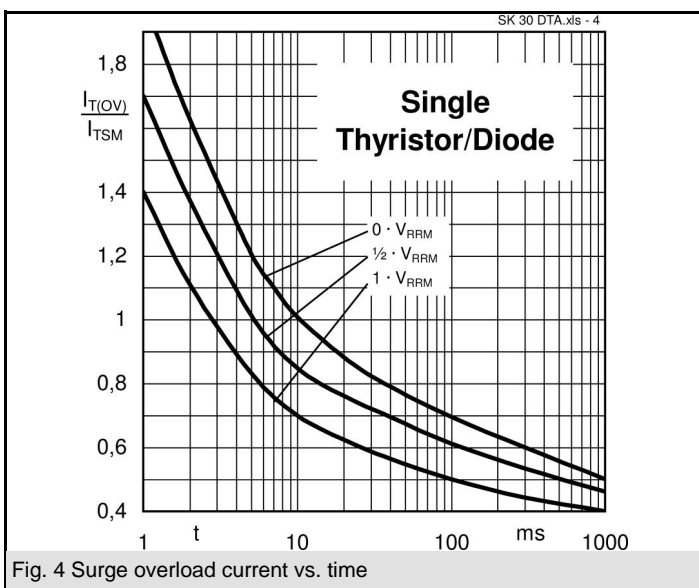
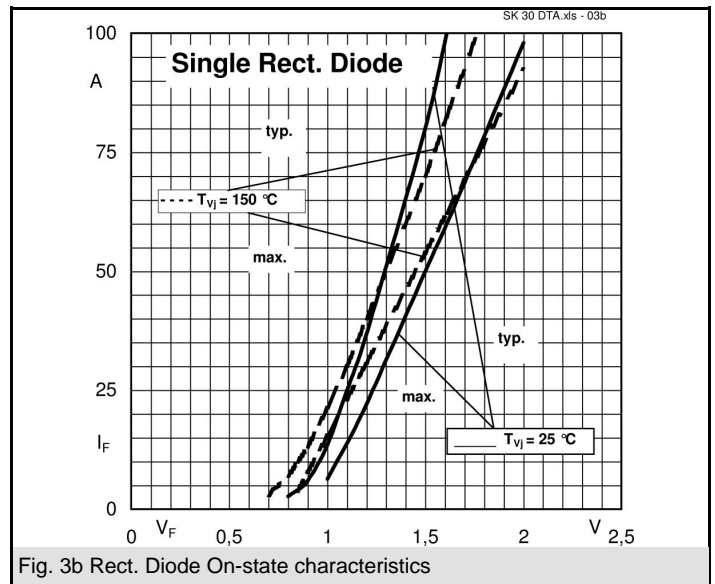
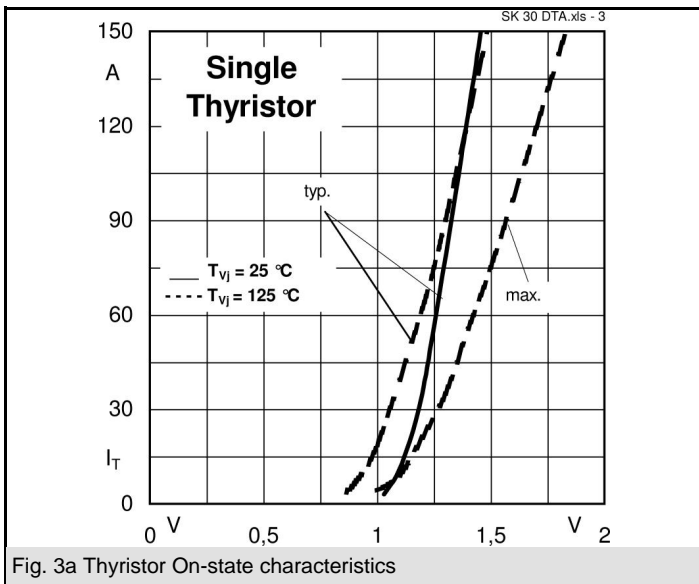
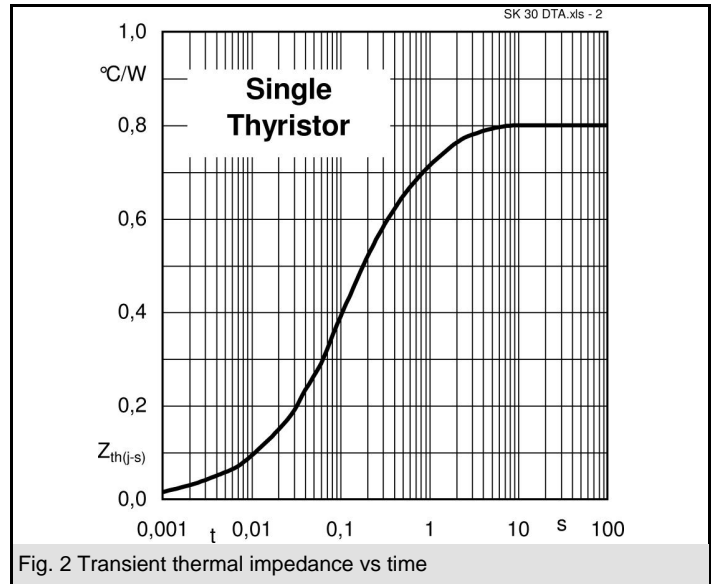
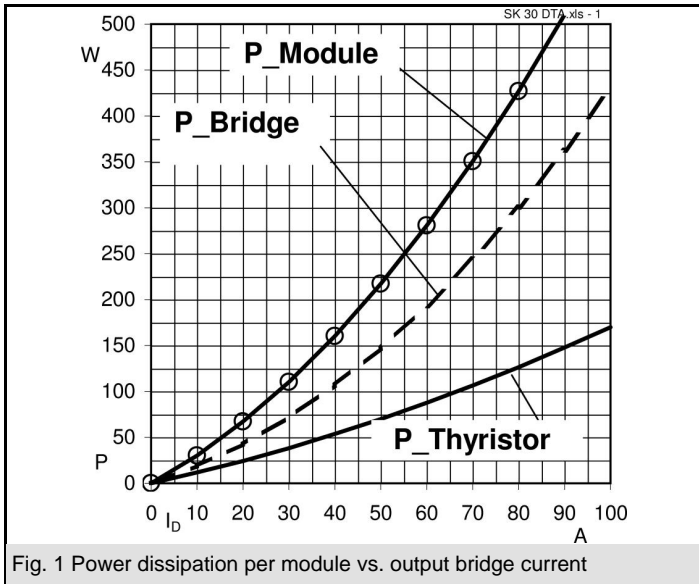

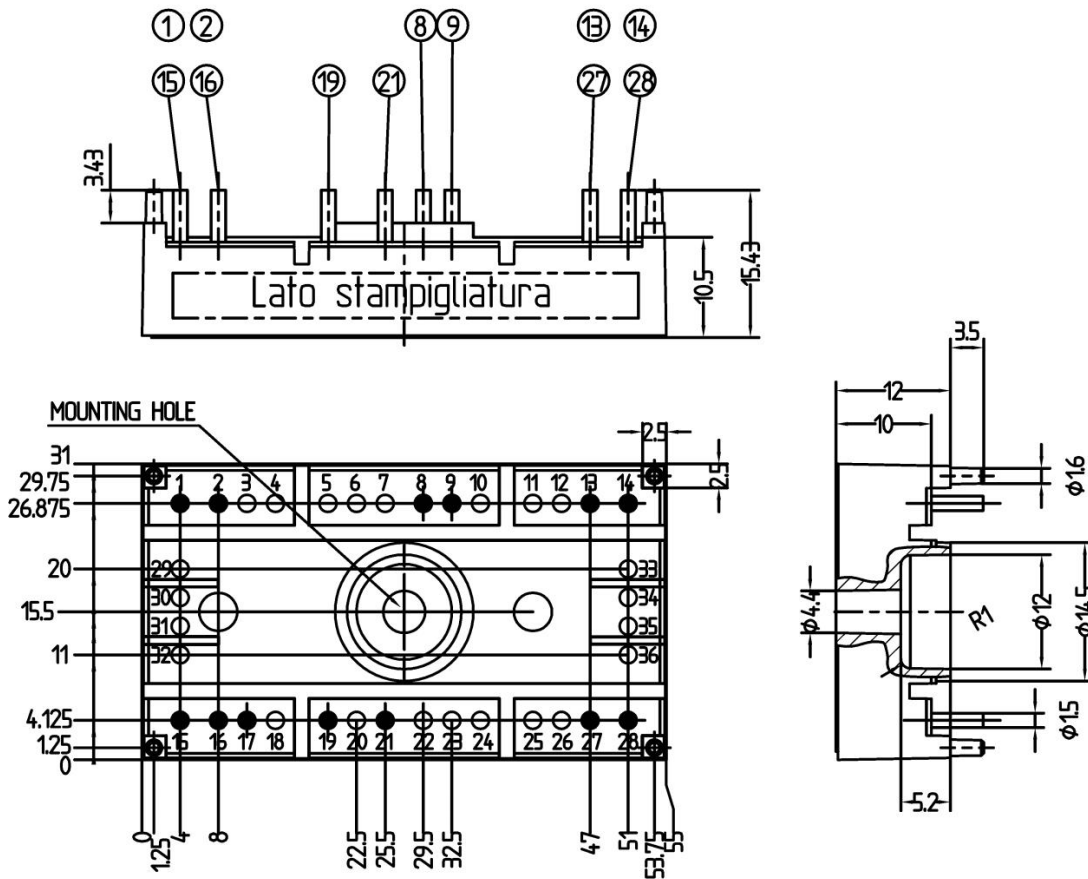

SUGGESTED HOLEDIAMETER FOR THE SOLDER PINS AND THE MOUNTING PINS IN THE PCB: 2 mm

Case T45 (Suggested hole diameter, in the PCB, for solder pins and plastic mounting pins: 2mm)

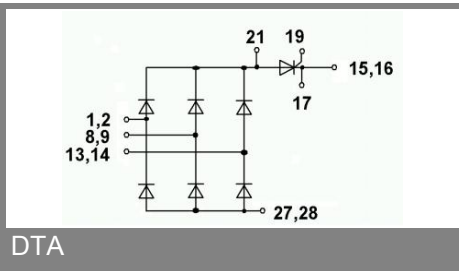

This is an electrostatic discharge sensitive device (ESDS), international standard IEC 60747-1, Chapter IX.

This technical information specifies semiconductor devices but promises no characteristics. No warranty or guarantee expressed or implied is made regarding delivery, performance or suitability.